

hotcontrol temperature controller C 148

Rapid commissioning

The temperature controller is preconfigured at the factory for the operation of a regulation zone using a pre-configured heating element and a thermocouple.

The commissioning of the control zone can therefore be executed in only a few steps.



Caution:

Commissioning may only be executed by specialist personnel!

The Symbol calls attention to an operating procedure, practice, or the like, which, if not correctly performed or adhered to, could result in personal injury or damage to or destruction of part or all of the product and system. Do not proceed beyond a warning symbol until the indicated conditions are fully understood and met.



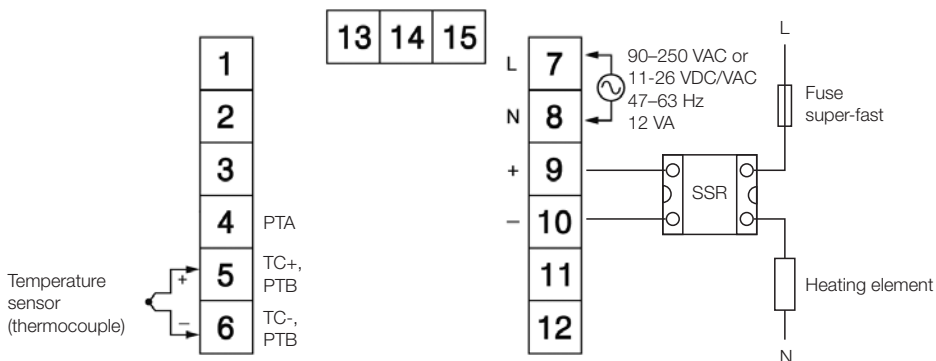

Step 1: Electrical connection

- Connect sensor (here thermocouple) between terminals 5 (+) and 6 (-).
- A solid state relay (SSR) is used as a power controller.
Observe the heating output to be connected during the selection of the SSR.
- Connect the control of the solid state relay to terminals 9 (+) and 10 (-) at the controller.
- Connect the heating to the supply voltage and solid state relay.
Use a super-fast fine-wire fuse or a super-fast circuit breaker to protect the heating circuit.
- Connect the supply voltage of the controller via terminals 7 and 8 (here 230 VAC).
Please also add a fuse here.

The design of the controller power supply must be observed (90–250 VAC or 24 VDC/VAC)!





Step 2: Set sensor type

- Press the  button until **INPUT** appears (normally 3 x).
- Select the sensor type using the **+button** or **-button**:
 - Example:  thermocouple type J
 -  thermocouple type K
- To exit, press the  button.

Step 3: Set nominal value

- Set the desired nominal value using the **+button** or **-button**.

Autotuning (if required)

- Press the  button until **AT** appears (approx. 6,4 s).
- Press the  button again for approx. 5 s, until the **AT indicator** flashes on the control panel. The self-adaptation (autotuning) will then begin.

The complete instruction manual
can be found at www.hotset.com/downloads/

