

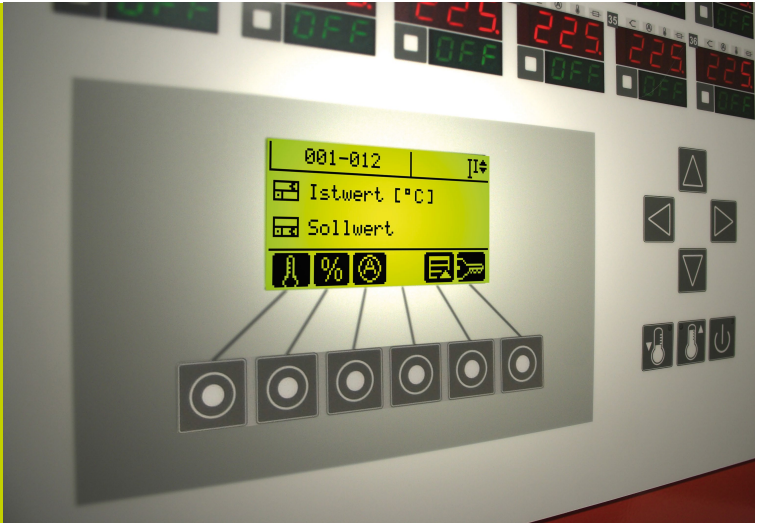

Operation

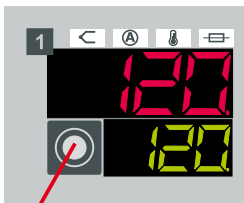

Quick entry for setpoint value



Zone selection key

Select zones by pressing the zone selection key in the LED display.

→ See zone selection

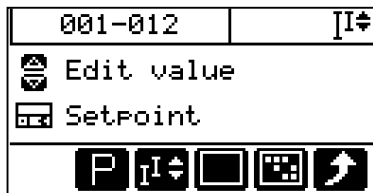

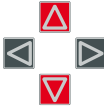
 Increase / decrease value for selected zones by up-/down-key of navigation keys

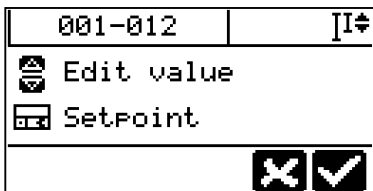

Confirm change
Reject change

 Heating must be switched on.

Keys / Displays & Help

LED display per zone

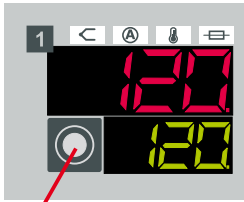

Zone selection key

Alarm LED's per zone

- < Sensor alarm
- A Current alarm
- 🌡 Temperature alarm
- 🔌 Fuse alarm

Navigation keys

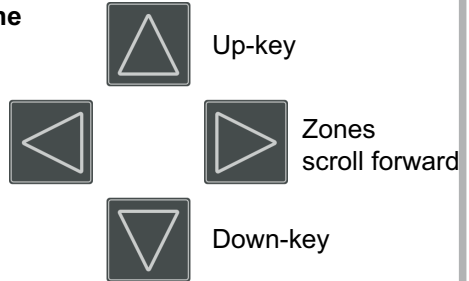

Soft keys

Number of zones

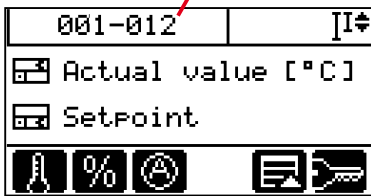

The 6 soft keys are assigned with different key symbols, adapted to context of screen page.

Here the basic menu is displayed.

Function keys

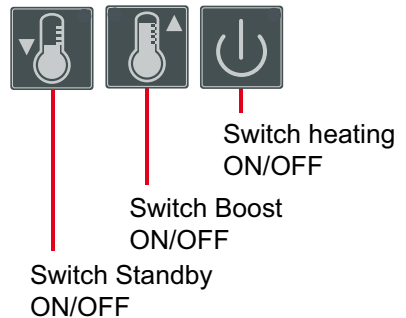

Allocation

LED display / LCD display

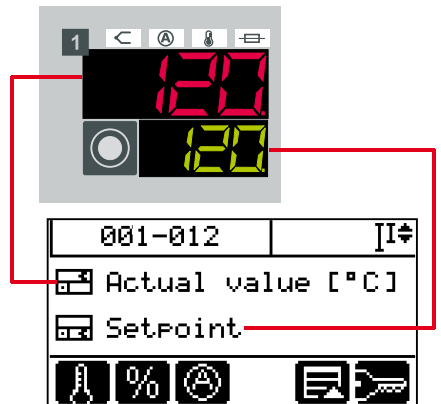

If there is no operation for at least 1 minute, the display returns to basic display.

Help

When a soft key is pressed longer than 3 seconds, the deposited help text for the key symbol is shown in the LCD display. Soft key for shows the following help:

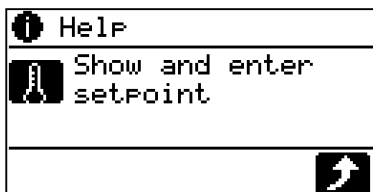

Zone selection

Zone selected



Zone selection key

Zone deselected



Are there any entries for zones, which need a zone selection, the following procedure has to be executed for zone selection.

The zones can be selected per zone by the zone selection key next to the LED display and/or by soft keys. The different selection methods can be combined in any order.

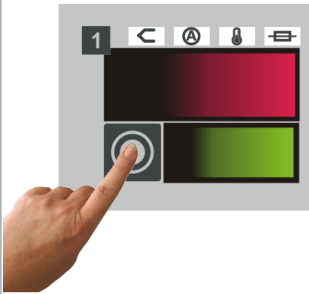

Select zones

Single The zones are selected/deselected by pressing the zone selection key.

Press zone selection key of the first zone of the block.

Block Double click on the last zone of the block. All zones in between the first and the last selected zone are shown as selected.



All

All zones are selected / All zones are deselected.



Group

Scroll the list of available groups by navigation keys. Confirm selected group.

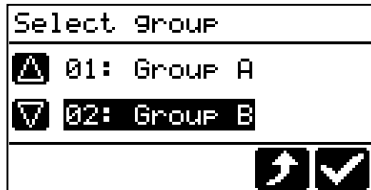

Scroll the list of available groups up/down by navigation keys

Confirm selected group
✓ / Cancel function ↵

The zones, defined by the group, are displayed as selected. An existing selection is canceled by this.

Set setpoint value

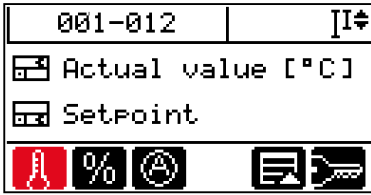

Select function

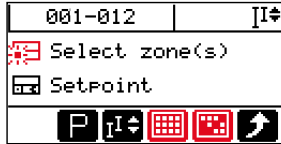

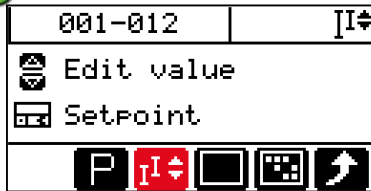

→ **See zone selection**

The zone displays for not selected zones is shaded



Is more than one zone selected and a numerical value is changed:

 Setpoint value of all selected zones is changed to the same value (first selected zone).

 Setpoint value of all selected zones is changed by the same value.

Current setting see LCD display in header top right.

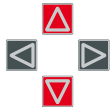

Increase / decrease value for selected zones by up-/down-key of navigation keys

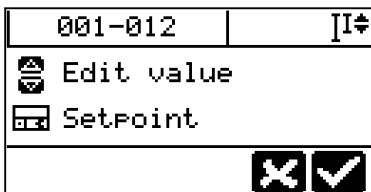

Confirm change 

Reject change 

Repeat entry for other zones



Change output value

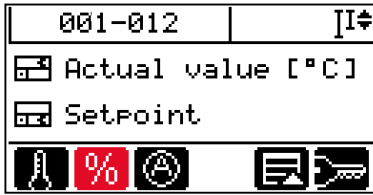

Zones with defective sensors can continue to operated in manual mode. The affected zones must be set to manual mode and an output value has to be entered manually.

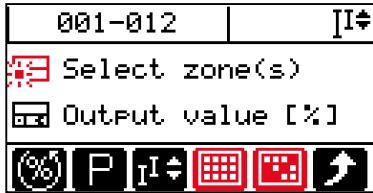

Select function

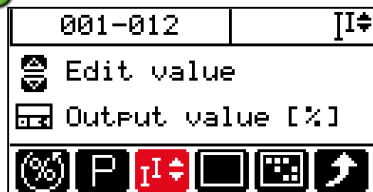

→ **See zone selection**

The zone displays for not selected zones is shaded.





Is more than one zone selected and a numerical value is changed:
 Output value of all selected zones is changed to the same value (first selected zone).
 Output value of all selected zones is changed by the same value.

Current setting see LCD display in header top right.

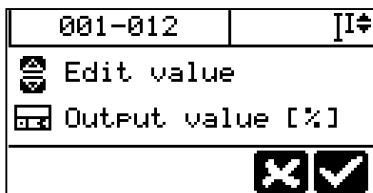

Increase / decrease value for selected zones by up-/down-key of navigation keys



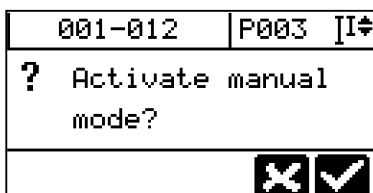

Confirm change 
 Reject change 

As soon as the zone is in manual mode, the LED display behind  shows setpoint value/output value.



The manual mode can be activated too, when changing the output value.

Confirm change 
 Reject change 

Repeat entry for other zones



Switch manual mode ON/OFF

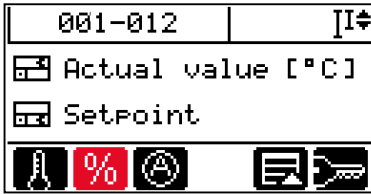

Zones with defective sensors can continue to operate in manual mode. The affected zones must be set to manual mode and an output value has to be entered manually.

Select function



Change mode to manual mode by key

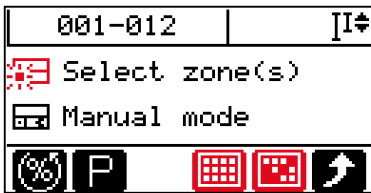

→ See zone selection

The zone displays for not selected zones is shaded.

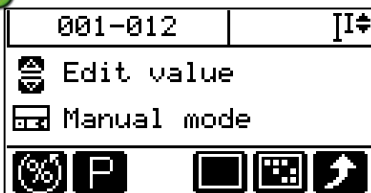



Edit value

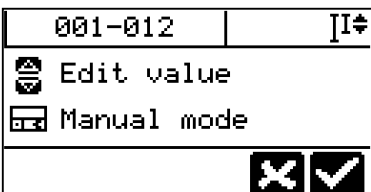

Select setting for selected zones by up-/down-key of navigation keys



Confirm change 
Reject change 

As soon as the zone is in manual mode, the LCD display behind  shows setpoint value/output value; MAn in the first line of the LED display alternates with current value, in the second line of the LED display the output value is shown.

Repeat entry for other zones



Execute current transfer

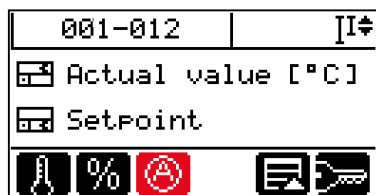

To monitor the floating current in the heater by comparison with reference values, the current setpoint value must be set automatically by current transfer and/or manually.

Select function

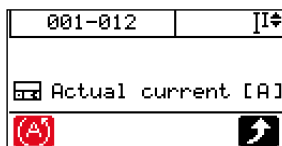

Change mode by key



Choose menu **Start current transfer?** (function call)

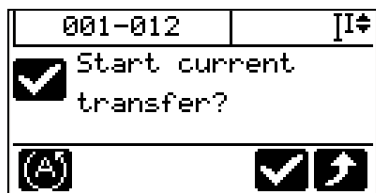

Start current transfer

Return to previous operator level

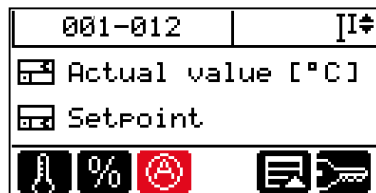

The current setpoint values can be changed after current transfer and/or be set manually for each zone.

Select function

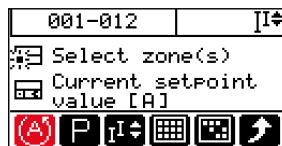

Change mode by key

Change to menu **Current setpoint value**



For

... zone selection

... .. entry absolute / relative

... .. increase/decrease value for selected zones

→ Procedure see set setpoint value

Display current actual value, residual current

001-012	I \updownarrow
Actual value [°C]	
Setpoint	
%	

Call display of the current actual value and the residual current.

Select function

001-012	I \updownarrow
Actual current [A]	

Change mode by key

Current actual value (only display)

Display in the second line of the LED display.

Return to previous operator level



001-012	I \updownarrow
Residual curr.[mA]	

Residual current (only display)

Measure current setpoint values automatically and save them.

Return to previous operator level



Parameters

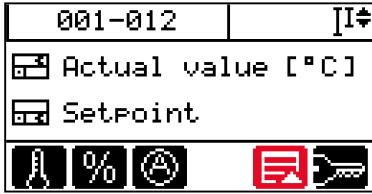

To show or to change all available parameters for the Standard user *) call the parameter menu by key.

The menu **Parameter** can always be called, as soon as the soft key **P** is displayed.



Select menu Parameter in menu (color-coded) and call .

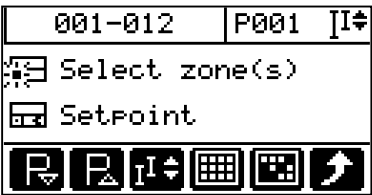

For

... zone selection

... .. entry absolute / relative

... .. increase/decrease value for selected zones

→ See set setpoint value



The parameter is selected by the scrolling with the keys.

The parameter number is in the header and in the second line of the LED display is the content of the parameter shown for each zone.

Scroll parameters forward



Scroll through all available parameters forwards starting from P001.

Scroll parameters backward



Scroll through all available parameters backwards starting from P001.

*) A Standard user can work with the system without login. The range of parameters is limited.

Standby

The Standby function can be used e.g. for the temperature reduction in case of production shutdown states. The function is activated/deactivated by key.



Press key

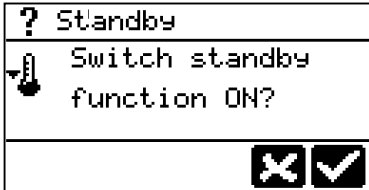

After activation of the Standby function, all zones (except zones in manual mode) are reduced by the setpoint value under parameter [P007 - Standby setpoint value].

Confirm

Reject



Standby function active is signaled by a LED top right in the key.

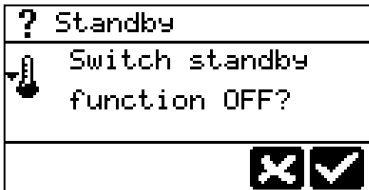

After deactivation of the Standby function, all zones are controlled by the setpoint value set.

Boost

The boost function can be used for the heating of the control zones prior to production start-up. The function is activated/ deactivated by key and/or ends after timer elapse.



Press key

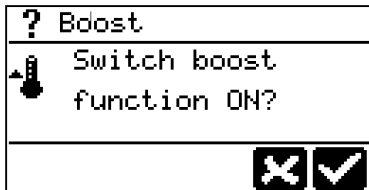

After activation of the Boost function, all zones (except zones in manual mode) are increased by the setpoint value under parameter [P008 - Boost setpoint value] for the time set under parameter [P018 - Boost time].

Confirm / reject



Boost function active is signaled by a LED top left in the key.



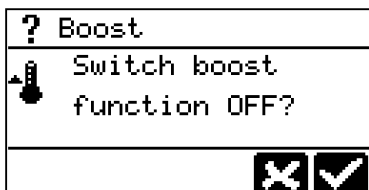









In the second line of the LED display the elapsing timer is shown.



After deactivation of the Boost function and/or after timer elapsed, all zones are controlled by the setpoint value set.

Alarm LED's / Information display / Error messages

Display in the first line of the LED display alternates with current value.

Error message	Description
 Sb	Sensor break
 SP	Sensor incorrect polarity
 FAL	Short circuit in sensor circuit
 Pot	Potential error
	Current tolerance error
 tHY	Thyristor alarm
 rSC	Residual current
 IOL	Current overload (Heater with too high power / short circuit in heating circuit)
 Hb	Total breakdown of heater / heater not connected
	Temperature outside limit value range
 TrG	Temperature range above maximal value
 FUS	Fuse failure / phase missing

System error	Description
ERR	Channel data error
SYS	System data error
hSE	Heat sink temperature too high
CAn	Communication error CAN bus internal

Status-message	Description
OFF	Actuator disconnected / Zone is passive (at heating release ON)
Dri	Drift error at identification
IdE	Error at identification
Id	Identification heating active
PLn	Learning phase process control active
PrO	Process monitoring not active yet
PAL	Process alarm
ErF	External reference alarm

Function	Description
MAn	Manual mode
SbY	Zone in Standby mode
bST	Zone in Boost mode *)
dIA	MoldCheck (diagnosis) active
HnD	Heat'n'Dry active
StA	Startup operation active *)
rAP	Manual temperature ramp active
Ar.	Automatic ramp active. Marking slowest zone
Ar	Automatic ramp active
CoU	Leading zone operation co-use #)

LED display second line *) display of time and/or #) display of number of leading zone

Alarm list

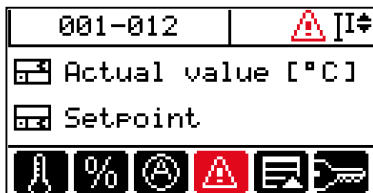

As soon as an alarm is detected in the system, e.g. due to a sensor break, the key symbol is shown and in the header the alarm pictogram starts flashing.

Are there no alarms, the key symbol and the pictogram are not visible.

Select function



The alarm list is displayed.

 By the up/down key of the navigation keys the list for the existing alarms can be scrolled. The zones, where an alarm exists (color-coded), are light in the LED display, the rest is shaded.

Are alarms, as well as information in the system available, both is shown in the key symbol.



Are the alarms gone, e.g. a sensor break is repaired, the non storing alarms are automatically deleted from the alarm list. The storing alarms must be acknowledged by the key.

Which alarms are storing, because they are critical, is fixed in the system.

InfoBoard



In the background, the system executes analysis permanently and informs the operator of important things by the InfoBoard. Is an information available, the key symbol is shown and in the header the pictogram for InfoBoard starts flashing.

Is there no information, the key symbol and the pictogram are not visible.

Select function

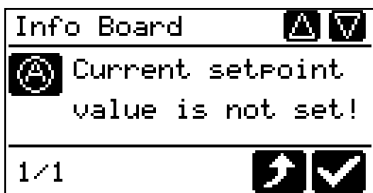

The InfoBoard is displayed.

 By the up/down key of the navigation keys the list can be scrolled for more information.

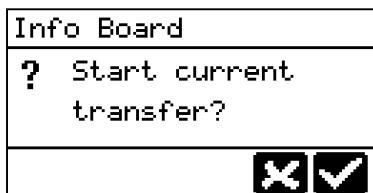

Beyond the information, the system recommends dedicated remedies, to support the operator solving problems.

Confirm 
Reject 

Login / Logout

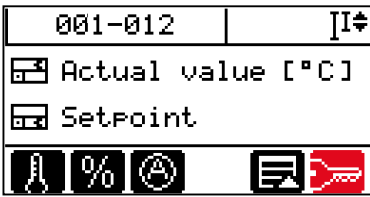

In addition to the Standard user, the user Professional and the user Admin are existing.
The user Professional and the user Admin are only activated after login.

Select function

Automated Login procedure



Is a key of a user on the connected USB stick available, this key is activated by pressing the key  in the hot runner controller (prerequisite same password). The active, logged in user can be seen in the key symbol.



Login user **Professional**

The standard passwords (Professional password: prof; Admin password: admin) should be changed after start-up of the system by the user Admin in the user administration.



Move cursor to the left



Move cursor to the right



Delete character before cursor position



Insert character before cursor position



Login user Professional

The login of user Professional is executed after entry of the corresponding password.

Confirm

Reject

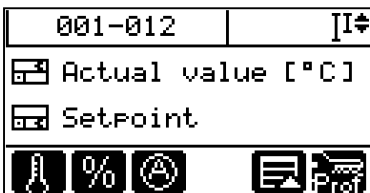

Is a user logged in, can this be seen in the key symbol Login.



A logged in user is logged off after selection of the key symbol and confirmation.

Confirm

Reject

Activate functions / Show menus



- Parameters
- Alarm list
- Zone Status
- Process monit.
- MoldCheck

The available functions and menus for the Standard user *) are combined shown.
The key displays the here shown functions / menus.

*) A Standard user can work with the system without login. The range of functions and menus is limited.

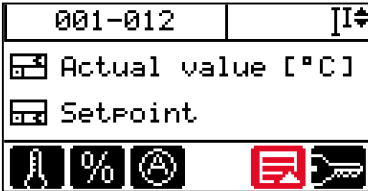

Select function



By the up/down key of the navigation keys the list can be scrolled for more functions/menus.

A selected function/menu (color-coded) can be called by key .

Return to previous operator level

MoldCheck ...

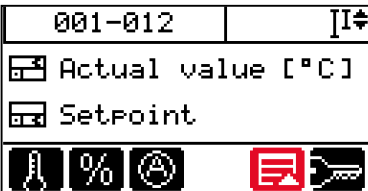

MoldCheck is a complete diagnosis of electric conditions of the hot runner and the corresponding peripherals.

Check setting of parameter [P028] MoldCheck max. wait time.

Select function



By the up/down key of the navigation keys choose MoldCheck (color-coded) and call it by key .



The call of the function must be confirmed.

Confirm

Return to previous operator level

... MoldCheck



→ See zone selection

The zone displays for not selected zones is shaded.

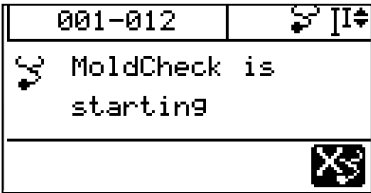

MoldCheck starts

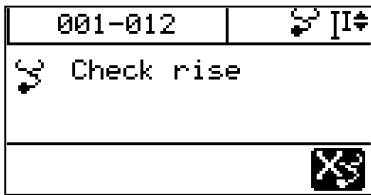

In this phase the display dIA - MoldCheck active (see Alarm LED's / Information display / Error messages) alternates with the display of the current value for all selected zones.

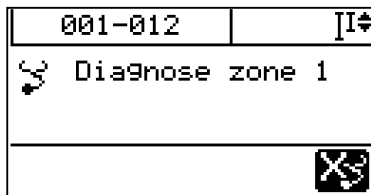

In this phase the display dIA - MoldCheck active (see Alarm LED's / Information display / Error messages) alternates with the display of the current value for the just analyzed zone (here 1).



Before calling MoldCheck result, a USB stick must be connected to the USB port. The MoldCheck result can be saved on USB stick by key .

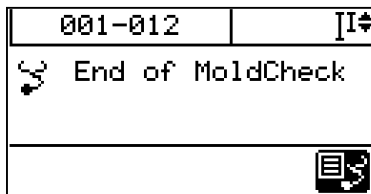

After diagnosis of all zones, the result can be called by key  at the end of the MoldCheck function.



The MoldCheck result list is displayed.

By the up/down key of the navigation keys the list can be scrolled for more results.



The selected result (color-coded) is shown in the second line of the LED display.

Leading zone operation

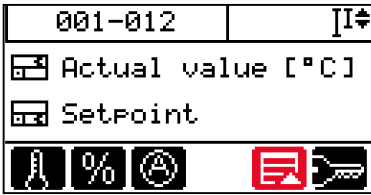

With the leading zone operation a zone with a defective sensor can be controlled by a similar zone with an intact sensor. The number of the leading zone must be set for the zone with the defective sensor, that it can be quasi controlled by it.

Select function



By the up/down key of the navigation keys choose Parameter (color-coded) and call it by key .



The parameter **Leading zone** is selected by scrolling forward and/or backward by the keys. The parameter number is in the header and in the second line of the LED display is the content of the parameter shown for each zone.

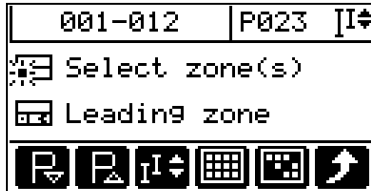

Parameter Leading zone is selected.

→ **See zone selection**

The zone displays for not selected zones is shaded.

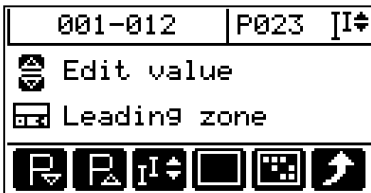

By the up/down key of the navigation keys the number of the leading zone can be set.

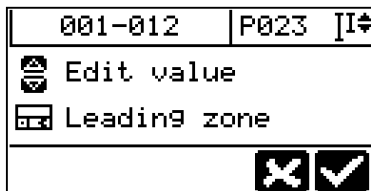

Edit

Confirm
Reject

As soon as the zone is in manual mode, the LCD display behind shows setpoint value/output value; MAn in the first line of the LED display alternates with current value, in the second line of the LED display the output value is shown.