

hotflex cs

Flexible tubular heater
with bendable unheated zones



Facts

- Easy installation with a uniform finish
- Can be formed by hand
- Stored in a straight condition to save storage space
- No special installation tools required
- Patented technology ensures industry leading heat transfer
- Up to 75% sheath contact with round and square hotflex heaters when recommended groove geometry is followed
- Rapid heat-up times
- Minimal temperature difference between heater sheath and heated tool
- 3-dimensional groove geometry possible
- Industry's smallest bending radius
- Hotflex's flexibility enables heat to be located where it is needed; an improvement over rigid cartridge heaters
- Reduced energy costs: tool mass can be reduced

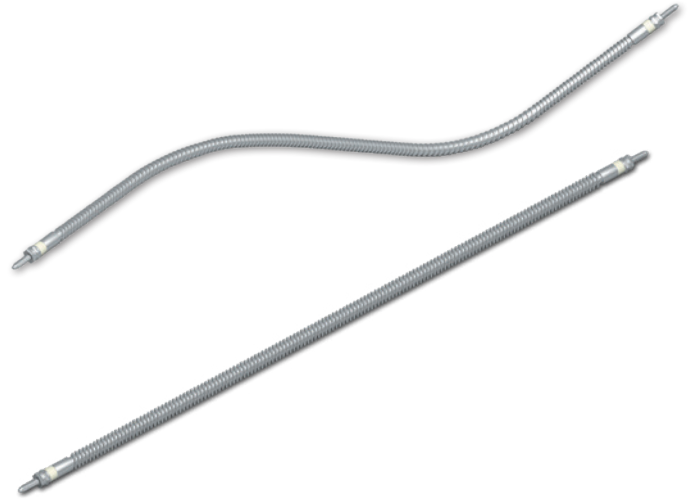

Technical Key Features

Sheath material	nickel
Sheath temperature of heating element	max. 700 °C / 1290 °F
Standard connection voltage	230 V
High voltage test*	1000 V AC
Insulation resistance*	≥ 5 MΩ at 500 V DC
Leakage current*	< 0.5 mA at 253 V AC
Min. Bending radius internal	10 mm
Wattage tolerance	± 10 %
Length tolerance	± 1.5 %

*tested at environmental temperature

Options

- Bendable unheated zones
- Connection voltage from 12 V to 250 V
- Individual length
- Individual wattage
- Individual connection options

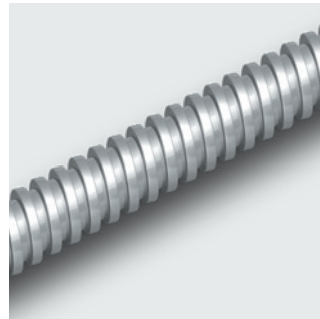

hotflex cs, round groove

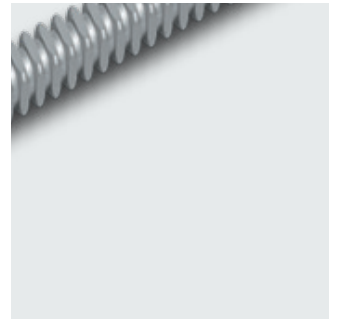

hotflex cs, square groove

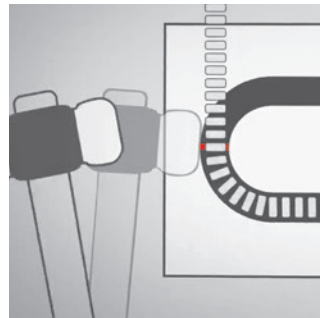

Installation without special tools



Ideal heat transfer

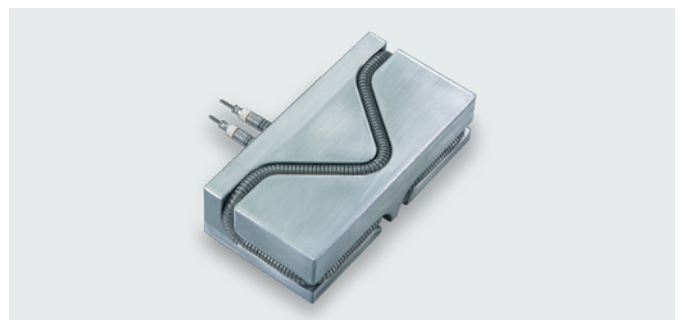

Installation example

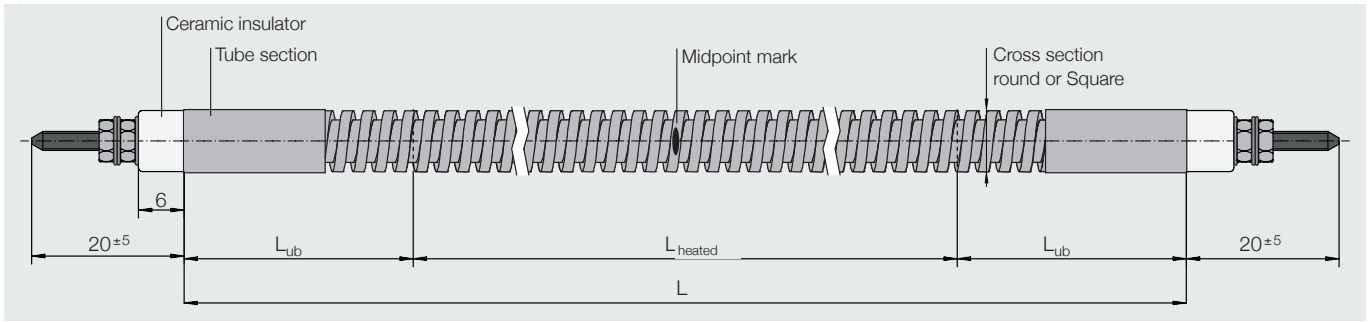

Type hotflex cs	L min [mm]	L max [mm]	Tube section max [mm]	L _{ub} [mm]	bendable	L not bendable [mm]	Min. Bending radius internal	Max. Sheath surface load [W/cm ²]
□ 6.0	350	2000	16	30	no	35	10	10
□ 6.0	350	2000	16	41	yes	–	10	10
□ 6.0	350	2000	16	100	yes	–	10	10
□ 6.0	350	2000	16	125	yes	–	10	10
∅ 6.5	350	2000	16	30	no	35	10	10
∅ 6.5	350	2000	16	41	yes	–	10	10
∅ 6.5	350	2000	16	100	yes	–	10	10
∅ 6.5	350	2000	16	125	yes	–	10	10

Depending on the number of bends the hotflex length can increase. For a more precise calculation of the extension you might use our template for assistance: www.hotset.com/hotflex_extensionfactors

Recommended groove geometry

Type hotflex cs	Groove dimensions [mm] b x h
□ 6.0 ±0.1	6.1 ±0.1 x 7.1 ±0.1
∅ 6.5 ±0.1	6.5 ±0.05 x 6.5 ±0.1

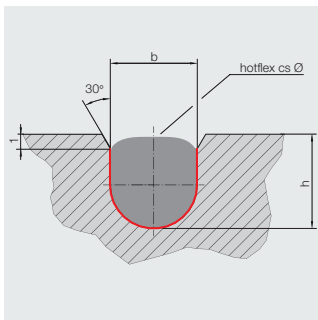

Round groove geometry

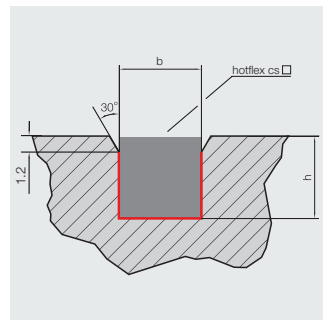

Square groove geometry

Connector types

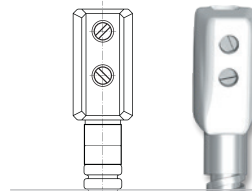

Ceramic terminal connector
"plug 'n' heat"
Temp. resist. 230 °C / 445 °F
Short term max. 280 °C / 535 °F
14 x 21 x 25 mm / 5.51 x 8.27 x 9.84"
available with stock items

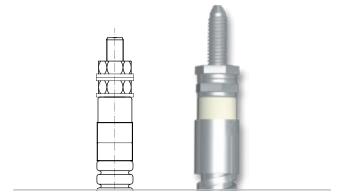

Standard: threaded pins M2.5
Option: M4 from ∅ 8.0 mm
with set of nuts and washers,
Temp. resist. 350 °C / 660 °F

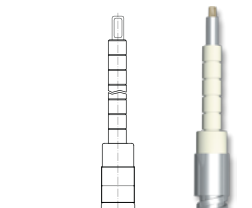

Plain Ni-leads with ceramic beads
insulation, up to 600 °C / 1110 °F

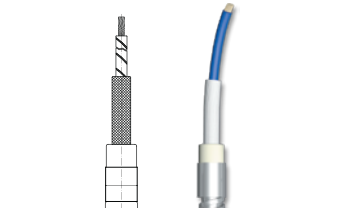

Insulated Ni-leads
Glass silk: up to 230 °C / 445 °F
PTFE: up to 230 °C / 445 °F
Silicon: up to 180 °C / 350 °F
Option: eyelet connector M4
available with stock items

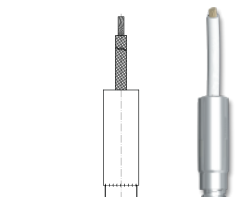

High temperature mineral fibre
insulated Ni-leads, with ceramic sealed
tube section

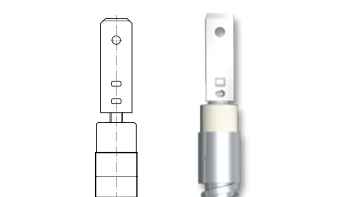

Flat plug, W = 6.3 mm / 0.248 inch,
Temp. resist. 350 °C / 660 °F
available with stock items



hotset

Hotset GmbH
Hueckstraße 16
58511 Lüdenscheid
Germany

Phone +49 / 23 51 / 43 02-0
Fax +49 / 23 51 / 43 02-25

www.hotset.com